

TUNE UP KIT (426224D5D)

O-RINGS (1/1 SCALE)

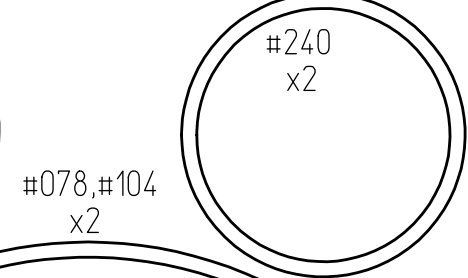
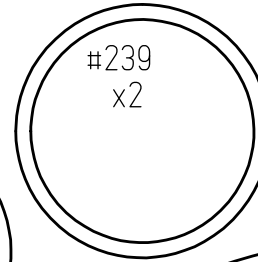
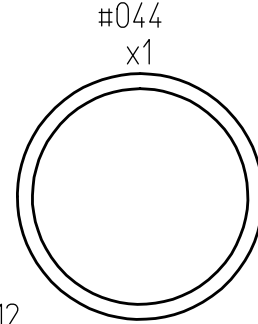
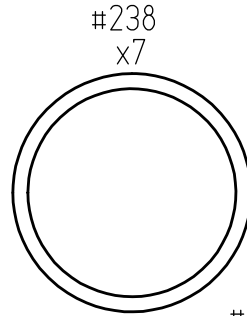
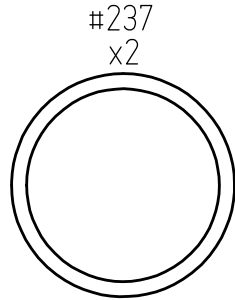
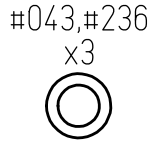

#078,#104
x2

12.08.03
x26224n1

#217
SIDE PACKING(N) x2

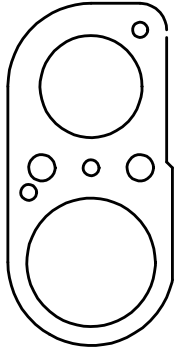

#218
VALVE PACKING x1

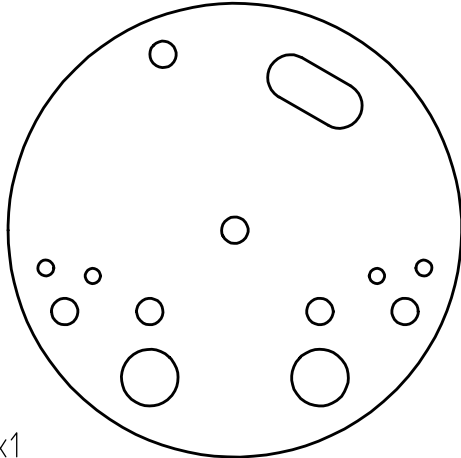

#112
x1

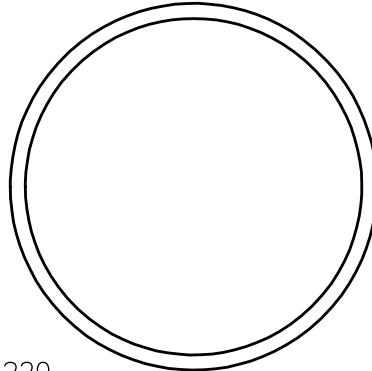

#103
x1

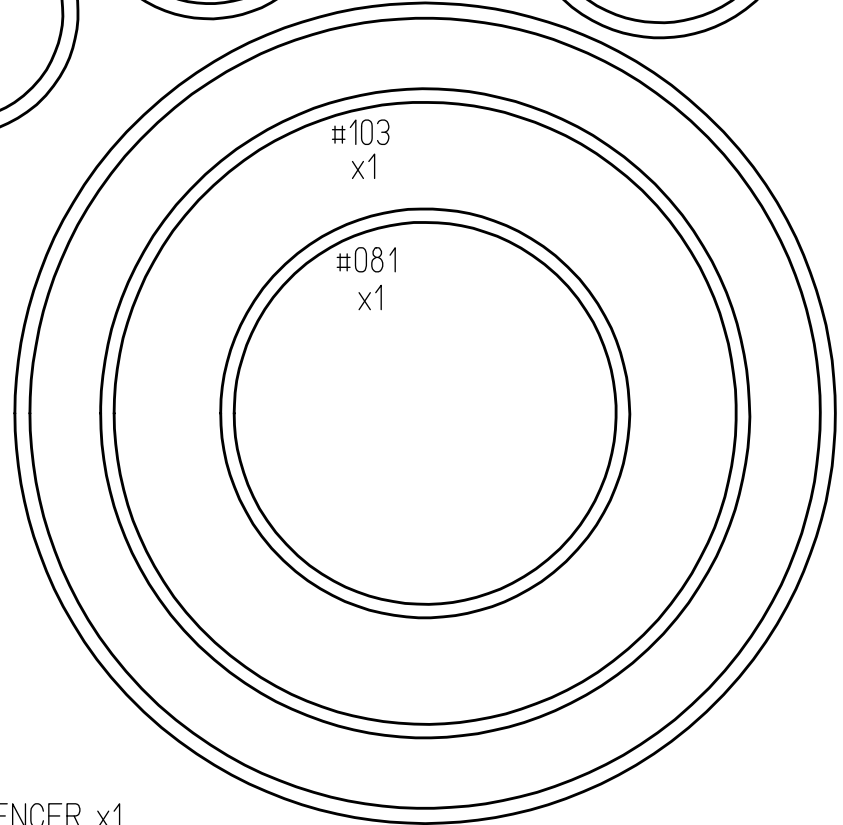

#081
x1

#219
TOP PACKING x1

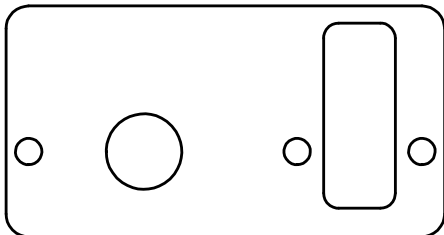

#220
UNDER PACKING x1

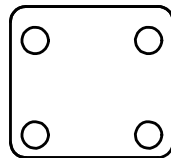

#222
NYLON SILENCER x1



#040
VANE x8

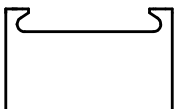

#041
LIFT SPRING x8

